

# FireCR

## User Manual

### Computed Radiography Scanner

**Doc No. : TM -701**

**Rev 0.1.2 November 2010**

**Part No. : CR-FPM-01-001**

**3DISC, FireCR, Quantor** and the **3D Cube** are trademarks of **3D Imaging & Simulations Corp.**, South Korea, and its affiliates. All other trademarks are held by their respective owners and are used in an editorial fashion with no intention of infringement. The data in this publication are for illustration purposes only and do not necessarily represent standards or specifications, which must be met by **3D Imaging & Simulations Corp.** All information contained herein is intended for guidance purposes only, and characteristics of the products and services described in this publication can be changed at any time without notice. Products and services may not be available for your local area. Please contact your local sales representative for availability information. **3D Imaging & Simulations Corp.** strives to provide as accurate information as possible, but shall not be responsible for any typographical error.

©Copyright 2010 **3D Imaging & Simulations Corp.**, all rights reserved, printed, and published in South Korea by **3D Imaging & Simulations Corp.**

**3DISC**  
3D Imaging & Simulations

## Contact

**3DISC**

3D Imaging & Simulations

815, Tamnip-Dong, Yuseong-Gu,  
Daejeon, Korea

Tel : 82-42-931-2100

Fax : 82-42-931-2299

Website : [www.3-disc.com](http://www.3-disc.com)

E-mail : [info@3-disc.com](mailto:info@3-disc.com)



3DISC Europe

Gydevang, 39-41, 3450 Alleroed, Denmark

Tel : 45-30-488-299

E-mail : [twe@3-disc.com](mailto:twe@3-disc.com)

**The device complies with Part 15 of the FCC Rules. Operation is subject to the condition that this device does not cause harmful interference.**

NOTE : This equipment has been tested and found to comply with the limits for a Class B Digital Device, pursuant to Part 15 of the FCC Rules. These limits are designed to provide reasonable protection against harmful interference in a residential installation. This equipment generates, uses and can radiate radio frequency energy and, if not installed and used in accordance with the instruction, may cause harmful interference to radio communication. However, there is no guarantee that interference will not occur in a particular installation. If this equipment dose cause harmful interference to radio or television reception. Which can be determined by turning the equipment off and on, the user is encouraged to try to correct the interference by one or more of the following measures :- Reorient or relocate the receiving antenna. - Increase the separation between the equipment and receiver - Connect the equipment into an outlet on a circuit different from that to which the receiver is connected. - Consult the dealer or an experienced radio/TV technician for help.

## **Warnings and Used Symbols**

To ensure the safety of patients, staff and other persons, any changes to software and hardware delivered by **3D Imaging & Simulations Corp.** may only be made with prior written permission from **3D Imaging & Simulations Corp.**

Please read the respective manuals of the connected software, such as acquisition and diagnostic software, before starting to use the **FireCR** system.

The following symbols will be used throughout this manual:



### **DANGER**

The functionality of the system can be destroyed in the case of incorrect use.

If unauthorized changes have been made to delivered system and accessories, the warranty by **3D Imaging & Simulations Corp.** becomes void. **3D Imaging & Simulations Corp.** will not accept any responsibility or liability for the proper functioning of the product in such a case.



### **WARNING**

The functionality of the system can be limited in the case of incorrect use. Hints that require special attention.



### **NOTE**

Notes represent information that is important to know but which do not affect the functionality of the system.

## **General Safety Guidelines**

All the safety and operating instructions should be read carefully before this device is operated.

This device has been designed and tested to meet strict safety requirements applicable to medical equipment, and has been supplied in a safe condition. To ensure personnel and patient safety, the device shall be operated and serviced in compliance with all procedures, warnings and precautions during all phases of operation and service of this device. Failure to comply to with safety guidelines may result in injury to service personnel, operator, or patient. **3D Imaging & Simulations Corp.** assumes no liability for failure to comply.

If this device is not used as specified, the protection provided by the device could be impaired. This device must be used in a normal condition only.

Installation, service and operation of this device should only be undertaken by qualified trained personnel. The operator should study instructions and precautions carefully before starting to use the device listed here and throughout the manual.

There are no user serviceable parts inside this device. The device should only be opened and serviced by qualified service personnel. Failure to heed this warning may result in injury to service personnel or damage to equipment, and void any and all warranties. If there is a service problem, please contact **3D Imaging & Simulations Corp.** or authorized dealer.

Do not spill liquids on the device, and never operate the device in a wet environment.

Keep the device from radiators and heat sources.

Use the device only with accessories supplied with this device.

This device is intended to be grounded. Plug power cord into properly grounded electrical outlets. This cord is equipped with three-prong plugs to help ensure proper grounding.

This device contains static sensitive components. Proper static handling procedures and equipment must be used when servicing this device.

Do not look inside of the device.

If any of the following conditions occur, unplug the device from the electrical outlet and contact authorized service personnel.

- The power cord or power adapter is damaged.
- An object has fallen into the device.
- The device has been exposed to water.
- The device has been dropped or damaged.
- The device does not operate correctly when the operating instructions are followed.

### **Intended Use**

This device is a Computed Radiography System and intended for use in producing digital X-Ray images for general radiography purposes. It comprises of scanner, cassette with reusable imaging plate and workstation software. It scans X-Ray exposed image plate and produces X-Ray image in digital form. Then, digital image is transferred to workstation for further processing and routing. This device is intended to be operated in a radiological environment by qualified staff.

***FireCR* is not approved for the acquisition of mammographic image data.**

# Index of contents

<i>Chapter 1. Introduction</i> .....	9
<i>Chapter 2. Unpacking</i> .....	11
2.1. <i>Inspection for Damage</i> .....	11
2.2. <i>Unpack the Shipping Container</i> .....	11
2.3. <i>Identify the Components</i> .....	13
<i>Chapter 3. Setting Up</i> .....	16
3.1. <i>Tabletop Mount</i> .....	16
3.2. <i>Wall Mount (Option)</i> .....	18
3.3. <i>Identify Important Features</i> .....	20
3.3.1. <i>Scanner Connecting Part</i> .....	20
3.3.2. <i>Scanner Status Indication LED</i> .....	20
3.3.3. <i>Scanner Reset Button</i> .....	21
3.4. <i>Computer Requirements</i> .....	22
3.4.1. <i>Recommended Requirement</i> .....	22
3.4.2. <i>Minimum Requirement</i> .....	22
3.5. <i>Installation of <b>QuantorMed / QuantorVet</b></i> .....	22
3.6. <i>Connect the Cable and Power Cord</i> .....	23
3.6.1. <i>Connect Interface Cable</i> .....	23
3.6.2. <i>Connect the Power Cord</i> .....	24
3.6.3. <i>Installation Report</i> .....	25
<i>Chapter 4. Operating</i> .....	26
4.1. <i>System Specifications</i> .....	26
4.2. <i>Operation Conditions</i> .....	27
4.3. <i>Operating Instructions</i> .....	28
4.3.1. <i>Turn on the Scanner</i> .....	28
4.3.2. <i>Turn on the Computer</i> .....	28
4.3.3. <i>Cassette Insert and Eject</i> .....	28
4.3.4. <i>Getting a Scanned Image</i> .....	28
4.3.5. <i>Circuit Functions</i> .....	29

**Chapter 5. Symbols ..... 30**

- 5.1. *Manufacturer’s Declaration - Electromagnetic Emission*..... 31
- 5.2. *Manufacturer’s Declaration - Electromagnetic Immunity* ..... 31
- 5.3. *Guidance and Manufacturer’s Declaration – Electromagnetic Immunity*..... 34

**Chapter 6. Warranty and Repair Service ..... 35**

- 6.1. *Standard Warranty*..... 35
- 6.2. *Repair Service* ..... 35
- 6.3. *Out of Warranty Repair Service*..... 35
- 6.4. *Shipping* ..... 36

**Chapter 7. Technical Assistance ..... 37**

## *Chapter 1. Introduction*

Thank you very much for deciding on **FireCR** – Computed Radiography Scanner.

The **FireCR** System is ideal for a wide range of Computed Radiography examinations in specialty practices such as chiropractors, podiatrists and orthopedists.

Also the **FireCR** is well suited for small clinics, and mobile units, performing directly at the patient with one compact and affordable package.

The **FireCR** can be configured for nearly every clinical application, and is designed for full DICOM connectivity, and allows user to setup the system to capture high quality X-ray images of any body parts with minimal steps including reading, processing, displaying and sending of the high quality image. All imaging parameters are optimized, resulting in digital images that can be enhanced, enlarged, duplicated, and sent to any location as a DICOM 3.0 file format in seconds with no loss of resolution.

Combine the system with reusable phosphor screen equipped **FireCR** cassettes and portable X-ray equipment, it can be used for X-ray exams everywhere it is needed, e.g. nursing facilities, forensic institutions, employee screenings etc.

The **FireCR** System is ideal for Computed Radiography examinations in busy clinics and specialty practices. Affordable, rugged, compact, lightweight, fast and effective **FireCR** System enables all imaging functions to be performed with the advanced image management software, a solution that can be adapted most clinical applications.

The **FireCR** Computed Radiography solution with enhanced workflow and improved productivity are the best solution for medium sized healthcare facilities and clinics. The **FireCR** System complements centralized CR and DR environments such as clinics, ER and OR departments.

## **Main Features**

### ***State-of-the-Art Scanning Mechanism***

**FireCR** adopts state-of-the-art scanning mechanism using swing mirror to construct its compact and rigid structure.

### ***High Throughput***

Its unique and patented dual direction scanning mechanism enables to improve the efficiency and high throughput.

### ***Scanning Resolution***

User selectable resolution of 100 $\mu$ m and 200 $\mu$ m allows user to make diagnosis on variable purposes.

### ***Detector***

High sensitive photomultiplier tube equipped in **FireCR** delivers high gain, wide dynamic range and high speed response for radiographic imaging.

### ***Powerful Acquisition and Diagnostic Software***

**QuantorMed / QuantorVet** Acquisition and Diagnostic Software is supplied with every **FireCR**, and its accurate and rapid data processing make the scanner more powerful.

## Chapter 2. Unpacking

### 2.1. Inspection for Damage

**FireCR** is shipped in a custom designed container to protect the scanner from external shock. Before unpacking the scanner, inspect the shipping container for damage. In case the container is damaged, notify the shipper immediately.

### 2.2. Unpack the Shipping Container

Open the shipping container by rotating butterfly shape lock and remove items from the container.

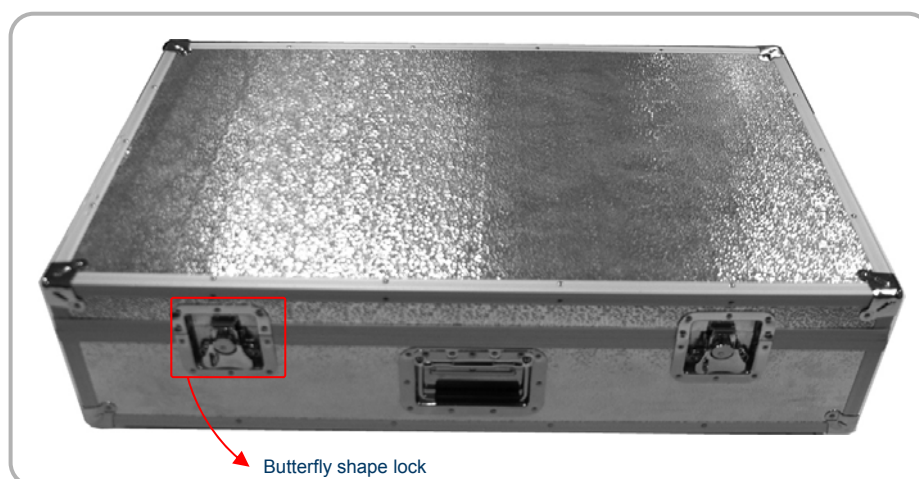

**Figure 1.** Shipping container

Open the shipping container, and remove the scanner and accessories as described below.

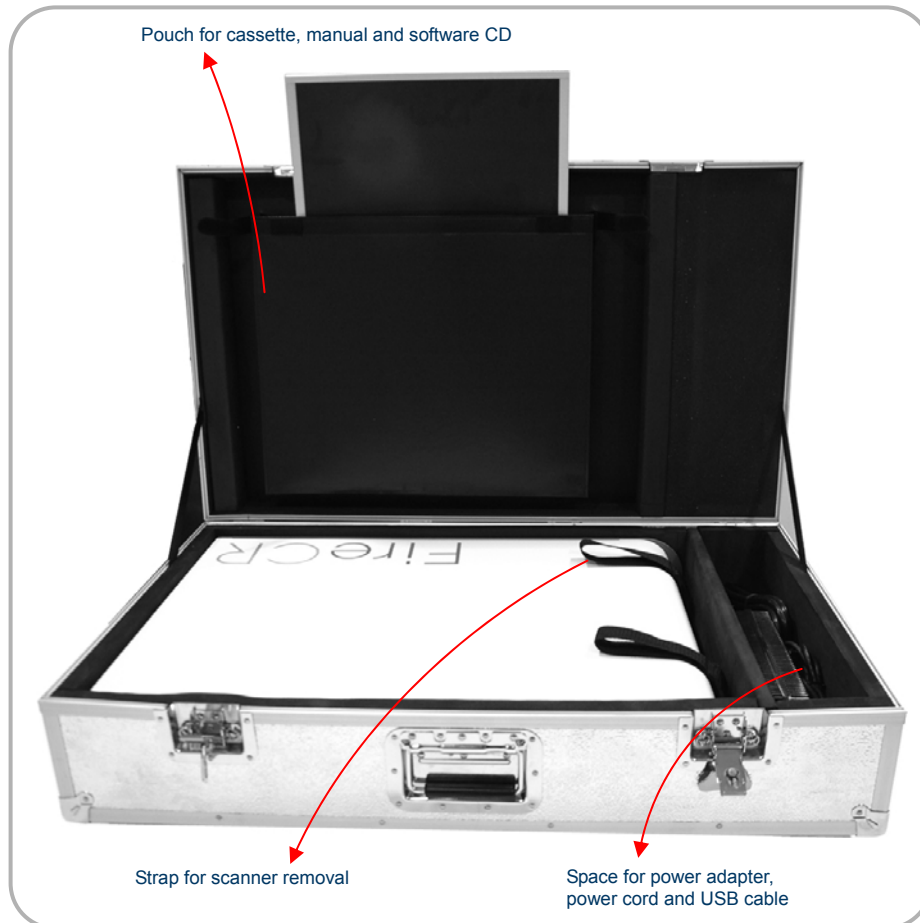

**Figure 2.** Inside of shipping container

Pull two straps to remove the scanner. And remove the cassette, manuals and **QuantorMed / QuantorVet** CD from the pouch attached to the lid.



**WARNING**

If the **FireCR** needs to be returned to manufacturer or one of its representatives, the scanner must be repacked in the original container with all accessories.



**DANGER**

Weight of the scanner is approximately 30kg (65lbs), and it requires two persons to lift.

## 2.3. Identify the Components

Identify each of these components.

Part No.	Item
CR-FP-01-00X	<b>FireCR</b> CR Scanner
CR-FP-02-003	Universal Cassette 14" x 17" containing IP size 14" x 17"
CR-FP-02-004	Universal Cassette 14" x 10" containing IP size 10" x 12"
	<b>Cassette Moving Plate Extractor</b>
CR-FPA-01-001	Power Adapter
CR-FPA-02-001	USB 2.0 Interface Cable
CR-FPA-03-00X	Power Cord
CR-PKM-01-001	Transportation Flight Case with Rollers
CR-FPM-01-001	<b>FireCR</b> User Manual



**FireCR** Computed radiography scanner

Extractor 그림 추가



14" x 17" Cassette  
(Imaging Plate Included)

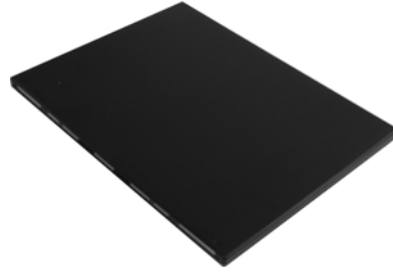

10" x 12" Cassette  
(Imaging Plate Included)



**FireCR** User manual



USB 2.0 Interface cable



Power adapter



Power cord

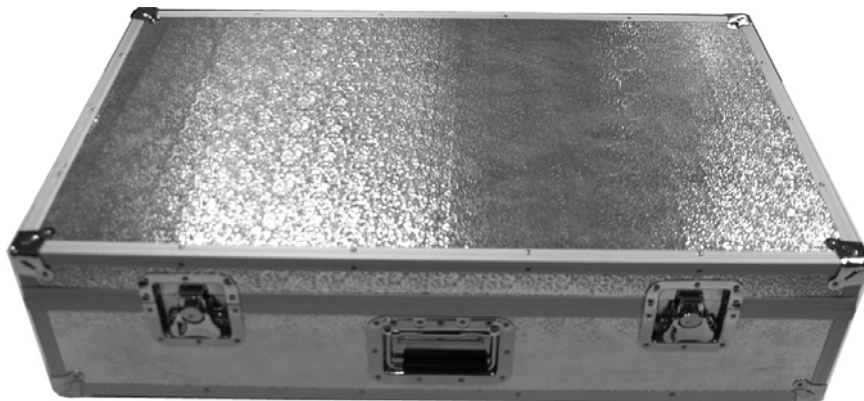

Transportation Case

**Figure 3. Components**

**WARNING**

Use of Power Cord;

Type SJT or SVT, min. 18AWG, 3-Conductor, VW-1 125V, min 10A (or 250V, 10A). Max 3.0m long; One end with Hospital Grade Type, NEMA 5-15P for 125V or NEMA 6-15P for 250V. Other end with appliance coupler. "CAUTION Grounding reliability can only be achieved when the equipment is connected to an equipment receptacle marked "Hospital Only" or "Hospital Grade".

For connection to supply not in USA, make sure the power cord is the correct type that is required in your area.

**WARNING**

Improper disposal of this product may result in environmental contamination. When disposing of this equipment, contact **3D Imaging & Simulations Corp.**'s representative or related organs of government. Do not dispose of any part of this equipment without consulting a **3D Imaging & Simulations Corp.**'s representative first.

**3D Imaging & Simulations Corp.** does not assume any responsibility for damage resulting from disposal of this equipment without consulting **3D imaging & Simulations Corp.**

**NOTE**

AC/DC Adapter

Manufacturer : Bridge Power corp.

Model : JMW1150XX24XFX (Xs are alphanumeric suffix not related to safety)

This adapter is passed by IEC60601-1.

**WARNING**

Use the device passed IEC60950-1 or IEC60601-1 for the product connected via USB port.

## Chapter 3. Setting Up



### WARNING

#### Unsuitable Installation Sites

- Locations with excessive humidity or dust
- Locations subject to high or temperature
- Locations subject to shaking or vibration
- Locations exposed to considerable electrical or magnetic noise, or other forms of electromagnetic energy
- Locations with poor heat radiation

### 3.1. Tabletop Mount

The scanner must be placed on a rigid and flat desk or tabletop with at least 10cm (4 inch) free space on both sides, 20cm (8 inch) on rear side and 50cm (20 inch) on front side for cassette insertion. Its space requirements are shown below.



**Figure 4.** Tabletop Mount Space Requirements (Top View)

In case that desk or table is not flat, adjust feet under the scanner for leveling. The scanner weighs approximately 30kg (65 lbs) and requires two persons to lift. Carefully place the scanner into its final position.

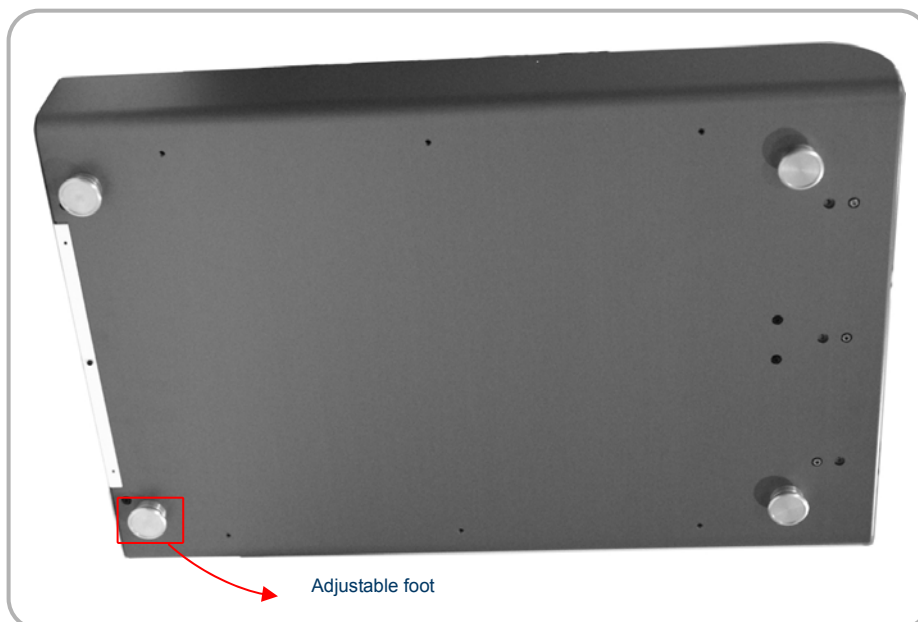

**Figure 5.** Scanner Leveling



**DANGER**

Never place the scanner on the floor.

Sliding the scanner may result in internal damage or misalignment of the optics.

Install in a location that is level and stable. Installation in an unsuitable location can cause accident, or deterioration in image quality.



**WARNING**

Sliding the scanner may result in internal damage or misalignment of the optics.

External vibration or shock during scanning may affect image quality. The scanner must be placed on rigid, flat and reinforced desk or tabletop.

**WARNING**

Do not place anything on top of the scanner.

**WARNING**

This equipment may be interfered or interfere by electromagnetic or other interference.

Assure a distance of minimum 1.0m with neighboring equipment.

### 3.2. Wall Mount (Option)

**FireCR** can be mounted on wall to save space occupancy. When purchasing the wall mount kit, a detailed installation manual and all parts necessary for assembly are provided.

**DANGER**

Only authorized or trained personnel should set wall mount installation.

**NOTE**

Refer to Wall Mount Installation Guide provided with Wall Mount Installation Kit.

**DANGER**

Install the wall mount on a solid wall perpendicular to the floor. When attaching to other building materials, please contact your dealer. If installed on a slanted wall, it may fall and result in severe injury.



**DANGER**

3D Imaging & Simulations Corp. is not liable for product damage or personal injury when the user fails to follow the product installation instruction.



**WARNING**

Pulling, pushing, or climbing on the system may cause the system fall.

Free space of 50cm (20 inch) on top side, at least, for cassette insertion and ejection.

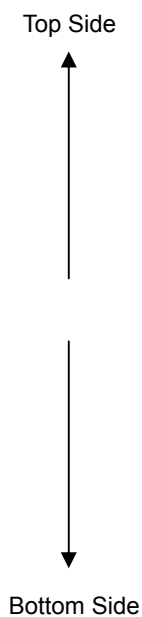

Free space of 10cm (4 inch) on both sides, at least.

Free space of 20cm (8 inch) on bottom side, at least, to allow the power switch, power cord and USB cord to be reached by hand at all times.

**Figure 6.** Wall Mount Space Requirements (Front View)

### 3.3. Identify Important Features

Look over the scanner and features shown in this section. User will need to know where these features are when user operates the scanner in later chapters.

#### 3.3.1. Scanner Connecting Part

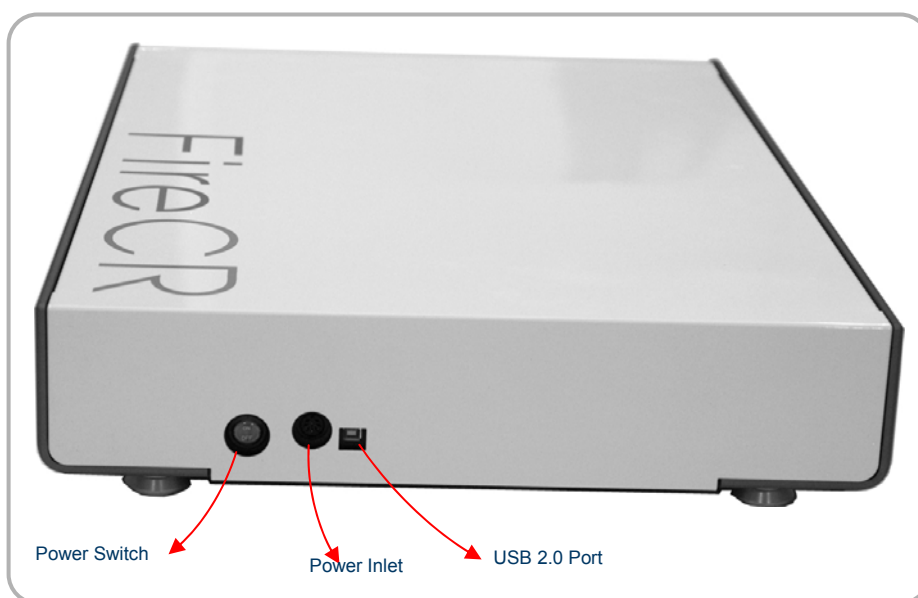

Figure 7. Scanner important features

#### 3.3.2. Scanner Status Indication LED

Indication LED shows the status of the scanner as described below.

LED		Status	Remark
Green	Blue		
	On	System On	
On		Ready to Scan	Cassette is in initial position, and ready to scan.
Blinking		Scanning	
	Blinking	Erasing	
Blinking	Blinking	Error	



**Figure 8.** Scanner status indication LED

### 3.3.3. *Scanner Reset Button*

In case that the scanner is stuck during scanning, push scanner reset button by sharp pin to initialize the scanner.

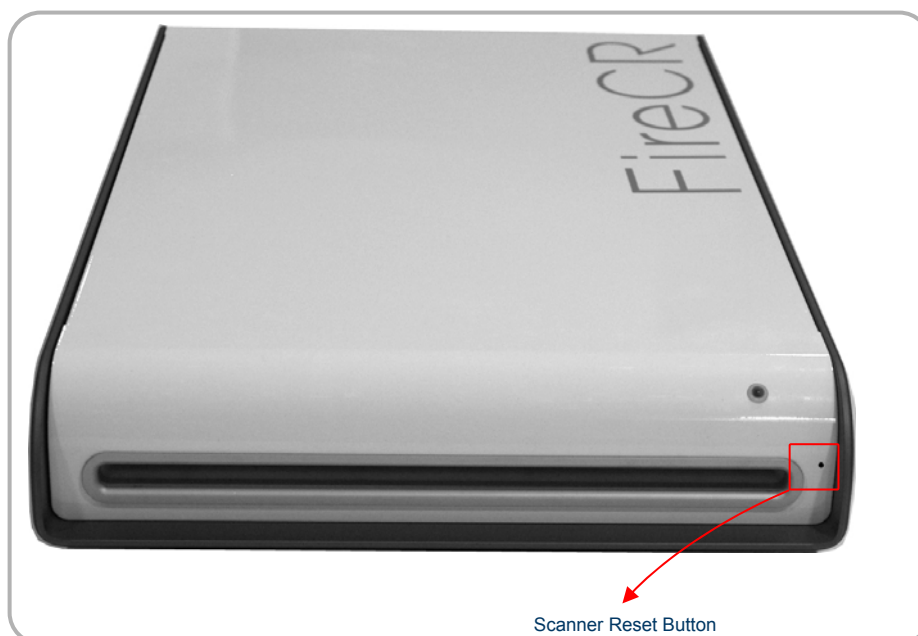

**Figure 9.** Scanner reset button

**WARNING**

Do not push scanner reset button during scanning.

### 3.4. Computer Requirements

#### 3.4.1. Recommended Requirement

Operation System	Microsoft Windows 7 (32bit)
CPU	Core Duo / Core2 Processor
Memory	RAM 4GB or more
Hard Disk	300GB Free Hard Disk Space
Network	1Gbps Ethernet
Video	32 bit Color Display
Video Resolution	1280 x 1024

#### 3.4.2. Minimum Requirement

Operation System	Microsoft Windows 7 (32bit)
CPU	Core Duo / Core2 Processor
Memory	RAM 2GB or more
Hard Disk	80GB Free Hard Disk Space
Network	1Gbps Ethernet
Video	32 bit Color Display
Video Resolution	1280 x 1024

### 3.5. Installation of **QuantorMed / QuantorVet**

Insert Installation CD, then install program will automatically launched. If install program does not launched automatically find and execute "**QuantorMed\_x.x.x.x\_installer.exe**" / "**QuantorVet\_x.x.x.x\_installer.exe**"file in CD. The setup will create a version of the **QuantorMed / QuantorVet** Acquisition and Diagnostic Software on the PC.

After installation, a **QuantorMed / QuantorVet** icon will be displayed on the desktop. By double clicking on the icon the **QuantorMed / QuantorVet** software starts.

**NOTE**

Refer to *QuantorMed / QuantorVet* Acquisition and Diagnostic Software manual.

### 3.6. Connect the Cable and Power Cord

#### 3.6.1. Connect Interface Cable

The scanner interfaces with computer via USB2.0 cable.

1. Use the USB cable in the shipping container.
2. Connect the cable to the scanner's USB2.0 port, located on the rear of the scanner.
3. Connect the other end of the cable to the USB2.0 port on the computer.



**Figure 10.** USB connection

**DANGER**

This equipment is indoor use only and all the communication wirings are limited to inside of the building.

**WARNING**

Do not pull out the USB cable during scanning.

### 3.6.2. Connect the Power Cord

1. Connect the power cord to the scanner, located on the rear side.
2. Connect the other end of the cord to a grounded power outlet.



**Figure 11.** Power connection

**DANGER**

This equipment must only be connected to supply mains with protective earth. Use only a three-wire cord that has grounding. This is a safety feature. If you are unable to insert the plug into the outlet, contact your electrician to replace your obsolete outlet. Do not defeat the safety purpose of the grounding-type plug.

**DANGER**

Do not use with any electrical power supply that does not meet the ratings displayed on the power adapter. Use with any other power adapter may lead to fire or electrocution.

**DANGER**

Do not use any power adapter and power cord other than the power adapter and power cord included with the system. Doing so may lead to fire, electrical shock, or electrocution.

**WARNING**

Socket-outlet shall be installed near the device and shall be easily accessible.

Do not place the device where difficult to access to appliance inlet.

Do not unplug the power cord or turn the power switch off during scanning.

### 3.6.3. *Installation Report*

After installation of the scanner, fill in Installation Report from (Appendix I) and send to **3D Imaging & Simulations Corp.** service department by fax or e-mail.

- Fax : +82-42-931-2299
- E-mail : support@3-disc.com

## Chapter 4. Operating

### 4.1. System Specifications

Sampling Pixel Pitch	Standard	200um
	High	100um
Pixel Matrix (IP 14" x 17")	Standard	1750 x 2150
	High	3500 x 4300
Pixel Matrix (IP 10" x 12")	Standard	1250 x 1500
	High	2500 x 3000
Accepted Cassette Size	14 " x 17", 14" x 10"	
Gray Scale Resolution	16 bit	
Eraser	Embedded	
Computer Interface	USB 2.0	
Dimensions	117 (H) x 464 (W) x 703 (D) mm 4.8 (H) x 18.3 (W) x 27.7 (D) inch	
Weight	30kg (65lbs)	
Power Requirement	100 ~ 240V / 50 ~ 60Hz	
System Configuration	Tabletop or Wall Mount	
Application Software	Included	
Image File Format	DICOM 3.0	

\* Specifications subject to change without notice.

\*\* Specific results may vary since operating conditions fluctuate.

## 4.2. Operation Conditions

Indoor use only	
Operating Temperature	0°C ~ 35°C (32°F ~ 95°F)
Temperature Gradient	0.5°C / Min
Relative Humidity	15% ~ 95% (non-condensing)
Storage Temperature	- 10°C ~ 50°C (14°F ~ 122°F)
Storage Humidity	15% ~ 95% (non-condensing)
Storage Atmospheric Pressure	500 ~ 1,060 hPa
Transportation Temperature	- 10°C ~ 50°C (14°F ~ 122°F)
Transportation Humidity	15% ~ 95% (non-condensing)
Transportation Atmospheric Pressure	500 ~ 1,060 hPa
Installation Category	II
Pollution Degree	2
Ingress of Liquids	IPX0
Altitude	Up to 2,000m
Protective Class	Class 1
Equipment Maintenance	No user maintenance is required and no user service is allowed. Please contact technical support if there is a problem.
Cleaning	Do not try to clean inside of the scanner. Wipe outside of the scanner for dust removing with soft and dry cloth.



### **DANGER**

There are no user serviceable parts inside the scanner. The scanner should only be opened and serviced by qualified service personnel. Failure to heed this warning may result in injury to service personnel or damage to equipment, and void any and all warranties. If there is a service problem, please contact **3D Imaging & Simulations Corp.** or authorized dealer.

## 4.3. Operating Instructions

### 4.3.1. Turn on the Scanner

Turn on the scanner. Power switch is on the rear side of the scanner.



#### **DANGER**

This device uses laser. Avoid looking inside of the scanner.

### 4.3.2. Turn on the Computer

Turn on the computer. **QuantorMed / QuantorVet** Acquisition and Diagnostic Software must be installed before operate the scanner.

### 4.3.3. Cassette Insert and Eject

Insert the cassette to the entrance of the scanner and push gently until it reaches to the protection wall inside of the scanner. Green indication LED is on when the cassette is inserted correctly. Insertion direction of the cassette must be parallel to the scanner.

Cassette can be ejected when scanning and erasing are completed. Gently pull back the cassette and ejection direction of the cassette must be parallel to the scanner.



#### **WARNING**

Do not insert the cassette in wrong direction or upside down when it is being inserted. Cassette insertion direction is marked on the cassette.

### 4.3.4. Getting a Scanned Image

To getting a scanned image, refer to **QuantorMed / QuantorVet** Acquisition and Diagnostic Software manual.



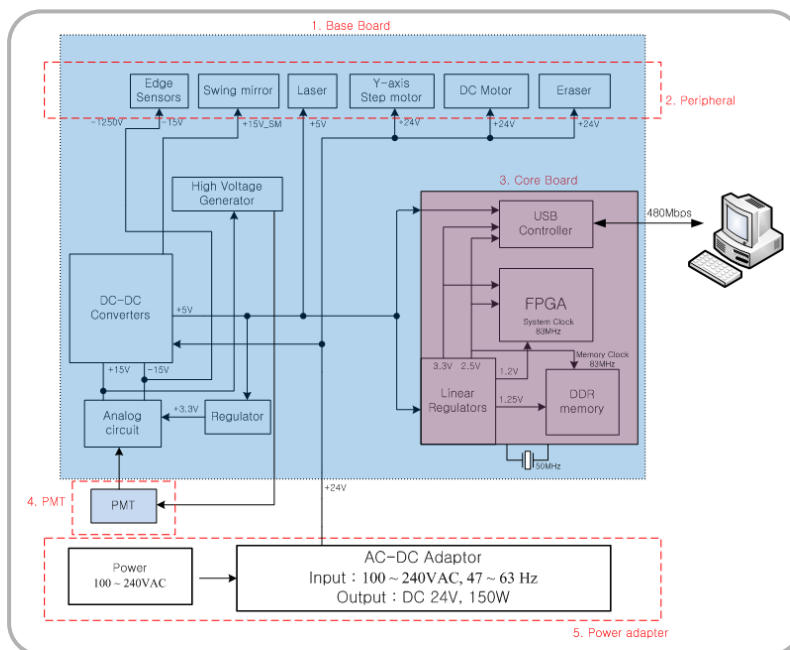

### 4.3.5. Circuit Functions



**Figure 11.** Circuit diagram

- ✓ **Base Board:**  
Base board is a controller of peripherals. It controls peripherals upon command of core board.
- ✓ **Peripheral:**  
This is peripherals for image acquisition. It consists of “Eraser” which erases residual images in imaging plate, “Step Motor and Photo Interrupters” which moves stage, “Laser, Swing Mirror and DC Motor” which are required to radiate laser onto imaging plate, “Edge Switch and DC Motor” which assures proper insertion of the cassette, and “Indicator” which displays the status of the system.
- ✓ **Base Board Image Data Controller (Core Board):**  
This parts controls peripherals for image acquisition. And it delivers amplified digitized signal to PC via USB.
- ✓ **Image Sensor (PMT):**  
This Photomultiplier Tube receives the signal through scanning of imaging plate, and it sends signal to analog readout circuit.
- ✓ **Power Adapter:**  
It supplies power to all modules of the system which are required for operation.

## Chapter 5. Symbols

Symbol	Description
	Warning, Consult Accompany Documents.
	Manufacturer
ON	Equipment Power On
OFF	Equipment Power Off
	Date of Manufacture
FCC ID : X68CRSCANNER	FCC Mark
	Medical Equipment WITH RESPECT TO ELECTRIC SHOCK FIRE, AND MECHANICAL HAZARDS ONLY IN ACCORDANCE WITH UL60601-1 / CAN / CSA CSS.2 No. 601.1 3SE3
	CE Mark

### 5.1. Manufacturer's Declaration - Electromagnetic Emission

<i>The <b>FireCR</b> system is intended for use in the electromagnetic environment specified below. The customer or the user of <b>FireCR</b> system should assure that it is used in such an environment</i>		
Emission test	Compliance	Electromagnetic environment - guidance
RF emissions CISPR 11	Group 1	The <b>FireCR</b> system uses RF energy only for its internal function. Therefore. Its RF emissions are very low and are not likely to cause any interference in nearby electronic equipment
RF emissions CISPR 11	Class B	The <b>FireCR</b> system is suitable for use in all establishments other than domestic and those directly connected to the public low-voltage power supplies buildings used for domestic purposes.
Harmonics emission IEC 61000-3-2	A	
Voltage fluctuation IEC 61000-3-3	Complies	

### 5.2. Manufacturer's Declaration - Electromagnetic Immunity

<i>The <b>FireCR</b> system is intended for use in the electromagnetic environment specified below. The customer or the user of <b>FireCR</b> system should assure that it is used in such an environment</i>			
Immunity test	IEC 60601 Test level	Compliance level	Electromagnetic Environment -guidance
Electrostatic discharge (ESD) IEC 61000-4-2	6 kV Contact 8 kV Air	6 kV Contact 8 kV Air	Floors should be wood, concrete or ceramic tile. If floors are covered with synthetic material, the relative humidity should be at least 30%
Electrical fast Transient / burst IEC 61000-4-4	2kV for power supply lines 1kV for input/output lines	2kV for power supply lines 1kV for input/output lines	Mains power quality should be that of a typical commercial or hospital environment.
Surge IEC 61000-4-5	1 kV differential mode 2 kV common mode	1 kV differential mode 2 kV common mode	Mains power quality should be that of a typical commercial or hospital environment.

<p>Power frequency (50/60Hz) Magnetic field IEC 61000-4-8</p>	<p>3.0 A/m</p>	<p>3.0 A/m</p>	<p>Power frequency magnetic fields should be at levels characteristic of a typical location in a typical commercial or hospital environment.</p>
<p>Voltage dips, short Interruptions and Voltage variations on power supply input lines IEC 61000-4-11</p>	<p>&lt;5% <math>U_T</math> (&gt;95% dip in <math>U_T</math>) for 0.5cycle  40% <math>U_T</math> (60% dip in <math>U_T</math>) for 5 cycle  70% <math>U_T</math> (30% dip in <math>U_T</math>) for 25 cycle  &lt;5% <math>U_T</math> (&lt;95% dip in <math>U_T</math>) for 5 s</p>	<p>&lt;5% <math>U_T</math> (&gt;95% dip in <math>U_T</math>) for 0.5cycle  40% <math>U_T</math> (60% dip in <math>U_T</math>) for 5 cycle  70% <math>U_T</math> (30% dip in <math>U_T</math>) for 25 cycle  &lt;5% <math>U_T</math> (&lt;95% dip in <math>U_T</math>) for 5 s</p>	<p>Mains power quality should be that of a typical commercial or hospital environment. If the user of the BSVD-1000 system requires continued operation during power mains interruptions, it is recommended that the BSVD-1000 system be powered from an uninterruptible power supply or a battery</p>
<p>Conducted RF IEC 61000-4-6</p>	<p>3 Vrms 150 kHz to 80 MHz</p>	<p>3 Vrms 150 kHz to 80 MHz</p>	<p>Portable and mobile RF communications equipment should be used no closer to any part of the <b>FireCR</b> system, including cables, than the recommended separation distance calculated from the equation applicable to the frequency of the transmitter.</p> <p><b>Recommended separation distance</b></p> $d = \left[ \frac{3,5}{V_1} \right] \sqrt{P}$
<p>Radiated RF IEC 61000-4-3</p>	<p>3 V/m 80.0 MHz to 2.5 GHz</p>	<p>3 V/m 80.0 MHz to 2.5 GHz</p>	<p><b>Recommended separation distance</b></p> $d = \left[ \frac{3,5}{E_1} \right] \sqrt{P} \quad 80 \text{ MHz to } 800 \text{ MHz}$ $d = \left[ \frac{7}{E_1} \right] \sqrt{P} \quad 800 \text{ MHz to } 2,5 \text{ GHz}$ <p>Where <math>P</math> is the maximum output power rating of the transmitter in watts (W) according to the transmitter manufacturer and <math>d</math> is the recommended separation distance in meters (m). Field strengths from fixed RF transmitters, as determined by an electromagnetic site survey, (a) Should be less than the compliance level in each frequency range (b).  Interference may occur in the vicinity of equipment marked with the following symbol:</p> 

**Note 1)**  $U_r$  is the A.C. mains voltage prior to application of the test level.

**Note 2)** At 80 MHz and 800 MHz, the higher frequency range applies.

**Note 3)** These guidelines may not apply in all situations. Electromagnetic propagation is affected by absorption and reflection from structures, objects and people.

**a** Field strengths from fixed transmitters, such as base stations for radio (cellular/cordless) telephones and land mobile radios, amateur radio, AM and FM radio broadcast and TV broadcast cannot be predicted theoretically with accuracy. To assess the electromagnetic environment due to fixed RF transmitters, an electromagnetic site survey should be considered. If the measured field strength in the location in which the EUT is used exceeds the applicable RF compliance level above, the EUT should be observed to verify normal operation. If abnormal performance is observed, additional measures may be necessary, such as re-orienting or relocating the EUT.

**b** Over the frequency range 150 kHz to 80 MHz, field strengths should be less than  $[V1] V / m$ .

**Recommended Separation Distances Between Portable and Mobile RF Communications Equipment and the FireCR system.**

The **FireCR** system is intended for use in an electromagnetic environment in which radiated RF disturbances are controlled. The user of the **FireCR** system can help prevent electromagnetic interference by maintaining a minimum distance between portable and mobile RF communications equipment (transmitters) and the **FireCR** system as recommended below, according to the maximum output power of the communications equipment.

Rated maximum output power (W) of transmitter	Separation distance (m) according to frequency of transmitter		
	150 kHz to 80 MHz	80 MHz to 800 MHz	800 MHz to 2.5 GHz
0.01	0.12	0.12	0.23
0.1	0.37	0.37	0.74
1	1.17	1.17	2.33
10	3.70	3.70	7.37
100	11.70	11.70	23.30

For transmitters rated at a maximum output power not listed above, the recommended separation distance (d) in meters (m) can be estimated using the equation applicable to the frequency of the transmitter, where P is the maximum output power rating of the transmitter in watts (W) according to the transmitter manufacturer.

**Note 1:** At 80 MHz and 800 MHz, the separation distance for the higher frequency range applies.

**Note 2:** These guidelines may not apply in all situations. Electromagnetic propagation is affected by absorption and reflection from structures, objects, and people.

Immunity and Compliance Level			
Immunity test	IEC 60601 Test Level	Actual Immunity Level	Compliance Level
Conducted RF IEC 61000-4-6	3 Vrms, 150 kHz to 80 MHz	3 Vrms, 150 kHz to 80 MHz	3 Vrms, 150 kHz to 80 MHz
Radiated RF IEC 61000-4-3	3 V/m, 80 MHz to 2.5 GHz	3 V/m, 80 MHz to 2.5 GHz	3 V/m, 80 MHz to 2.5 GHz

### 5.3. Guidance and Manufacturer’s Declaration – Electromagnetic Immunity

The <b>FireCR</b> system is intended for use in the electromagnetic environment specified below. The customer or the user of <b>FireCR</b> system should assure that it is used in such an environment			
Immunity test	IEC 60601 Test level	Compliance level	Electromagnetic environment - guidance
Conducted RF IEC 61000-4-6	3 Vrms 150 kHz to 80MHz	3 Vrms 150 kHz to 80 MHz	<b>FireCR</b> system must be used only in a shielded location with a minimum RF shielding effectiveness and, for each cable that enters the shielded location with a minimum RF shielding effectiveness and, for each cable that enters the shielded location
Radiated RF IEC 61000-4-3	3 V/m 80.0 MHz to 2.5GHz	3 V/m 80.0 MHz to 2.5GHz	Field strengths outside the shielded location from fixed RF transmitters, as determined by an electromagnetic site survey, should be less than 3V/m.  Interference may occur in the vicinity of equipment marked with the following symbol:  
<p><b>Note 1)</b> These guidelines may not apply in all situations. Electromagnetic propagation is affected by absorption and reflection from structures, objects and people.</p> <p><b>Note 2)</b> It is essential that the actual shielding effectiveness and filter attenuation of the shielded location be verified to assure that they meet the minimum specification.</p>			
<p><b>a-</b> Field strengths from fixed transmitters, such as base stations for radio (cellular/cordless) telephones and land mobile radios, amateur radio, AM and FM radio broadcast and TV broadcast cannot be predicted theoretically with accuracy. To assess the electromagnetic environment due to fixed RF transmitters, an electromagnetic site survey should be considered. If the measured field strength outside the shielded location in which the EUT is used exceeds 3V/m, the EUT should be observed to verify normal operation. If abnormal performance is observed, additional measures may be necessary, such as relocating the EUT or using a shielded location with a higher RF shielding effectiveness and filter attenuation.</p>			

## *Chapter 6. Warranty and Repair Service*

### *6.1. Standard Warranty*

**3D Imaging & Simulations Corp.** warrants its non-consumable hardware products to be free from defects in materials and workmanship. The warranty covers the cost of parts and labor to repair the product. Please keep the shipping container for future use. Products returned to the factory for repair should be properly packaged. To obtain warranty service, follow the procedure described in the Repair Service section. Failure to do so will cause long delays and additional expense to the customer.

The warranty is valid when the product is used for its intended purpose and does not cover products which have been modified without written permission from **3D Imaging & Simulations Corp.**, or which have been damaged by abuse, accident or connection to incompatible equipment.

This warranty is in lieu of all other warranties, expressed or implied.

### *6.2. Repair Service*

The company reserves the right to cease providing repair maintenance, parts and technical support for its non-consumable hardware products five years after a product is discontinued. Technical support for old versions of software products will cease 12 months after they are upgraded or discontinued.

### *6.3. Out of Warranty Repair Service*

Out of warranty repair service is available. Contact the supplier for current rates.

## 6.4. Shipping

The **FireCR** is a solidly built system designed to survive shipping around the world. However, in order to avoid damage during shipping, the **FireCR** must be properly packaged.

In general, the best way to package the **FireCR** is in the original factory container. If this is no longer available, we recommend that user carefully wraps the **FireCR** in at least 75mm (3 inch) of foam or bubble pack sheeting. The wrapped device should then be placed in a sturdy cardboard carton. Mark the outside of the box with word **FRAGILE** and an arrow showing which way is up.

We do not recommend using loose foam pellets to protect the **FireCR**. If the carton is dropped by the shipper, there is a good chance that the device will shift within the loose pellet packing and be damaged.

It is user's responsibility to package the system properly before shipping. If the packaging is inadequate, and the system is damaged during shipping, the shipper will not honor user's claim for compensation.

## *Chapter 7. Technical Assistance*

If user has any questions about installing or using the device, contact ***3D Imaging & Simulations Corp. Technical Support.***

### ***3D Imaging & Simulations Corp.***

815, Tamnip-Dong, Yuseong-Gu, Daejeon, Korea

Tel : 82-42-931-2100      Fax : 82-42-931-2299

[www.3-disc.com](http://www.3-disc.com)

## Appendix I

### Installation Report

Please complete this report at the time of installation and submit the completed form signed by customer to:

- Fax : +82-42-931-2299
- E-mail : support@3-disc.com

Date of Installation :

#### Customer Information

Hospital / Institute	
Name	
Address	
Tel	
Fax	
E-mail	

#### Installer Information

Company	
Name	
Address	
Tel	
Fax	
E-mail	

#### System Information

Model	<b>FireCR</b> CR Scanner
System S/N	
Software Version	
Software S/N	

Installer's Signature:

Date:

Customer's Signature:

Date: